

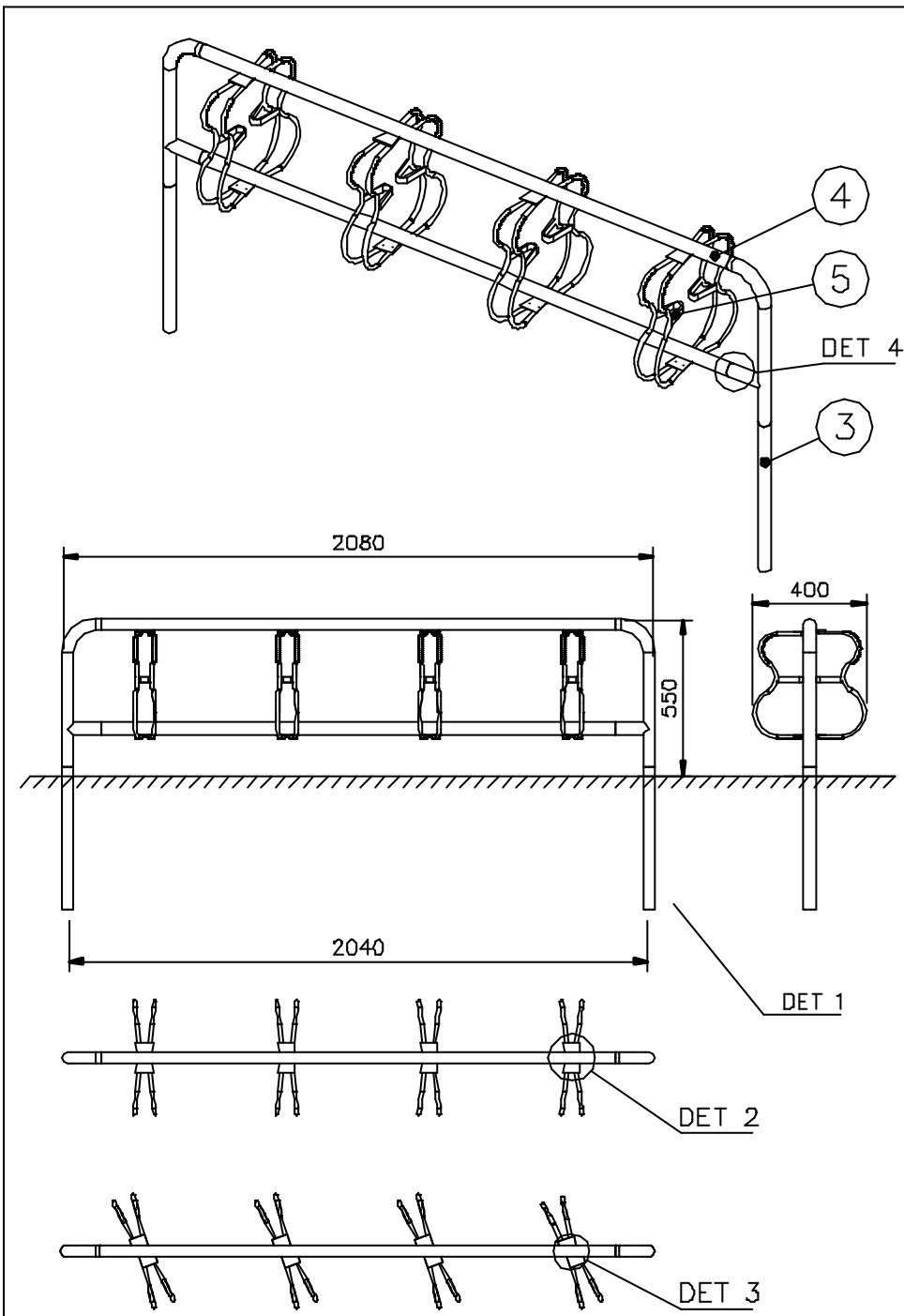



NF7620A

DATUM: 30.9.2003

1(1)

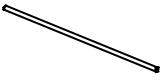
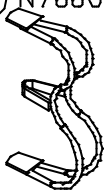
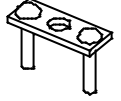
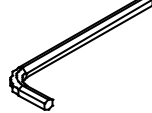

① N00103	ST	② ND1830	ST
	4		8
M6		8x30	
③ N76601	ST	④ N76603	ST
	2		2
⑤ N76605	ST	⑥ N76606	ST
	8		8
⑦ N00104	ST		ST
	1		

DET 4

