

NF9008

DATUM: 19.11.2004

1(1)

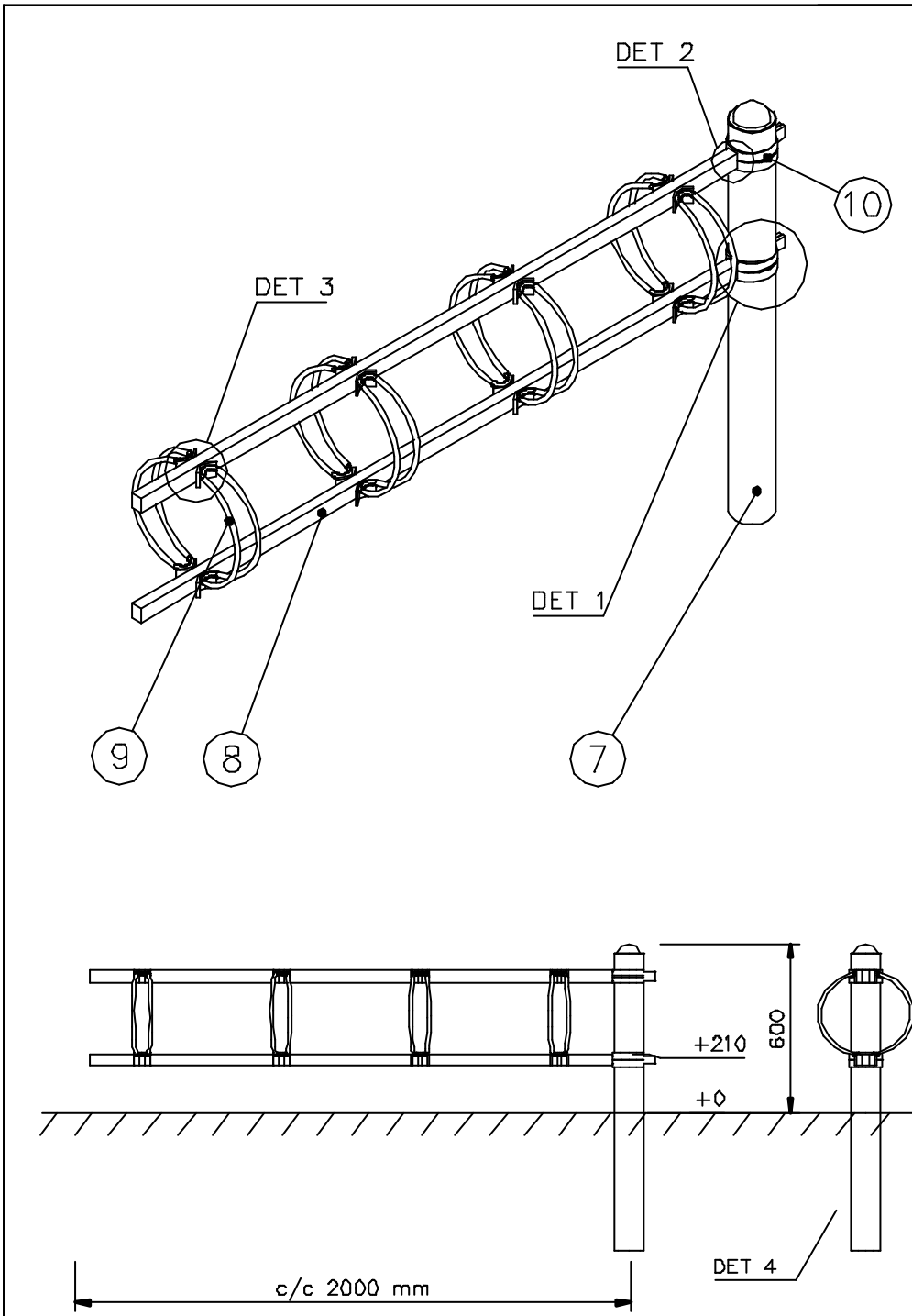

① N00106	ST	② N00126	ST
	4		2
8x20		M6x16	
③ N01801	ST	④ N01812	ST
	8		4
M8		8x12	
⑤ N01850	ST	⑥ N03816	ST
	8		12
8x50		8,4x16x1,5	
⑦ N90002	ST	⑧ N90004	ST
	1		2
⑨ N90005	ST	⑩ N90008	ST
	8		4
⑪ N00107	ST		ST
	1		

