

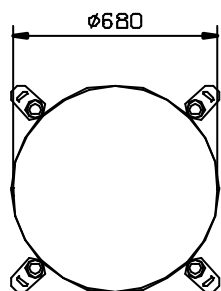

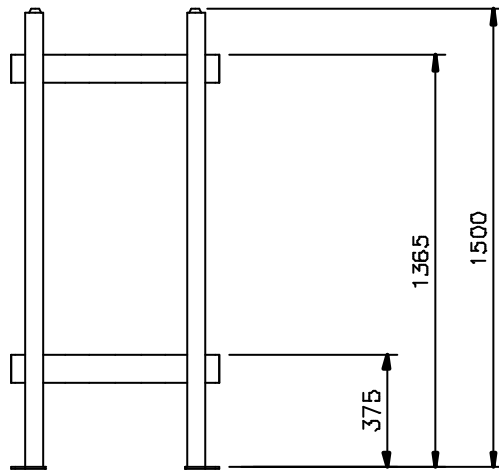

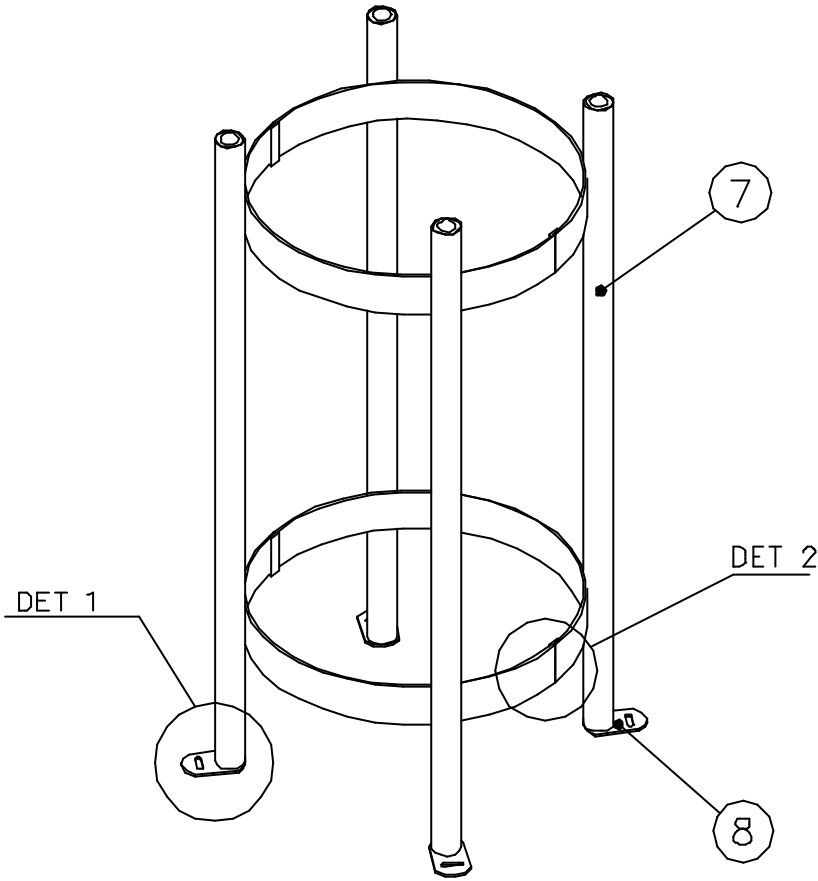



NF7720

DATUM: 1.10.2003

1(1)

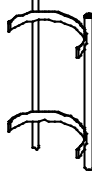

① N01800	ST	② N01820	ST
	4		4
M8		8x20	
③ N03816	ST	④ N21200	ST
	4		4
		M12	
⑤ N31228	ST	⑥ N76317	ST
	4		4
		M12	
⑦ N77201	ST	⑧ N77202	ST
	2		4

DET 1

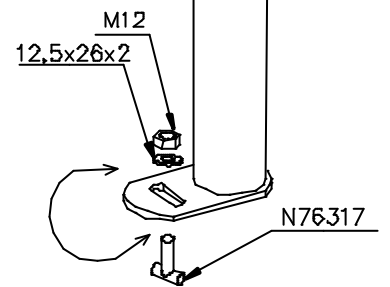

Rotate foot for heightadjustment

DET 2

