

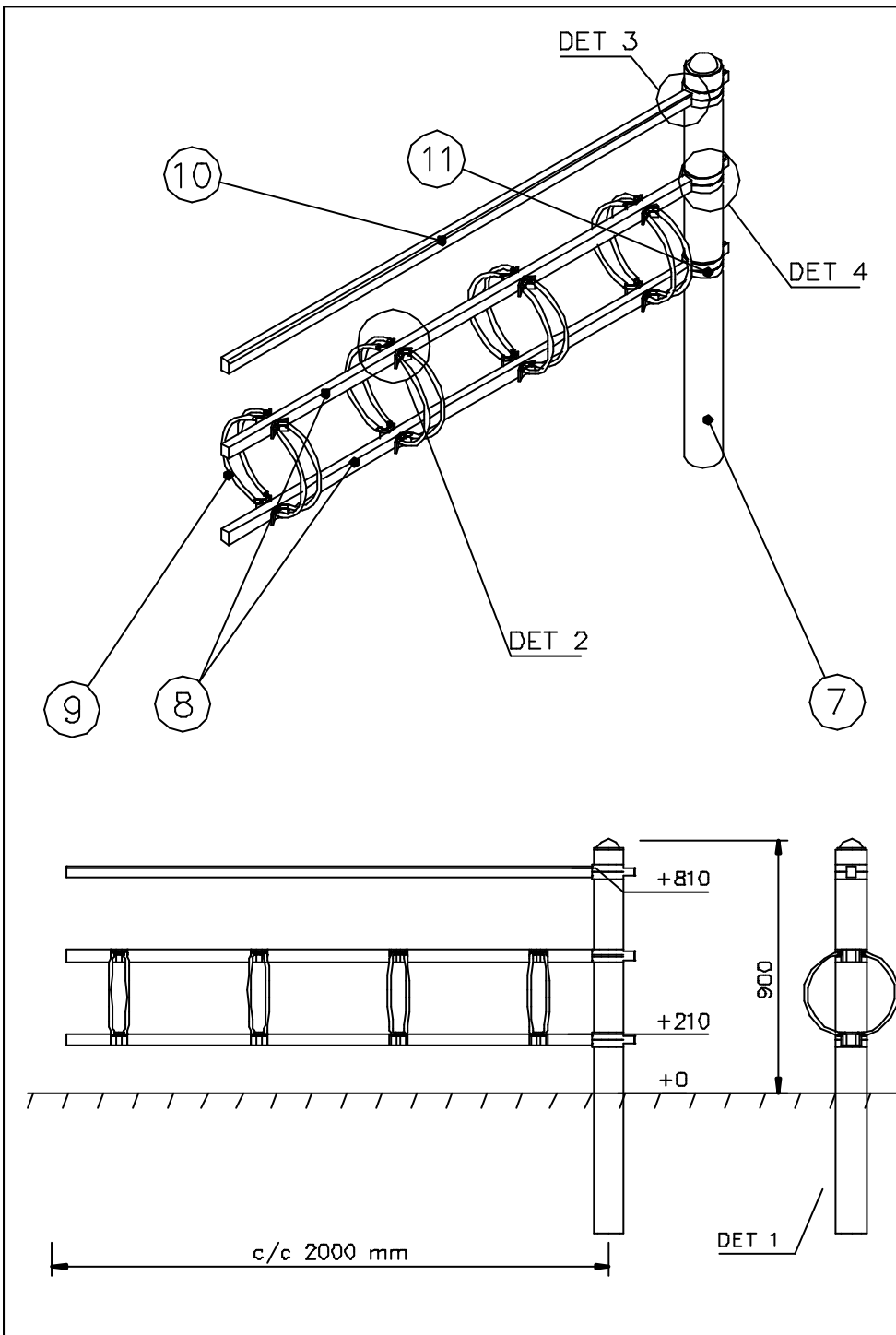









NF9016

DATUM: 22.11.2004

1(1)

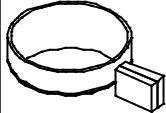
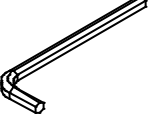

| | | | |
|---|----|---|----|
| ① N00106 | ST | ② N00126 | ST |
|  | 6 |  | 3 |
| 8x20 | | M6x16 | |
| ③ N01801 | ST | ④ N01812 | ST |
|  | 8 |  | 6 |
| M8 | | 8x12 | |
| ⑤ N01850 | ST | ⑥ N03816 | ST |
|  | 8 |  | 8 |
| 8x50 | | 8,4x16x1,5 | |
| ⑦ N90001 | ST | ⑧ N90004 | ST |
|  | 1 |  | 2 |
| ⑨ N90005 | ST | ⑩ N90003 | ST |
|  | 8 |  | 1 |
| ⑪ N90008 | ST | ⑫ N00107 | ST |
|  | 6 |  | 1 |

