

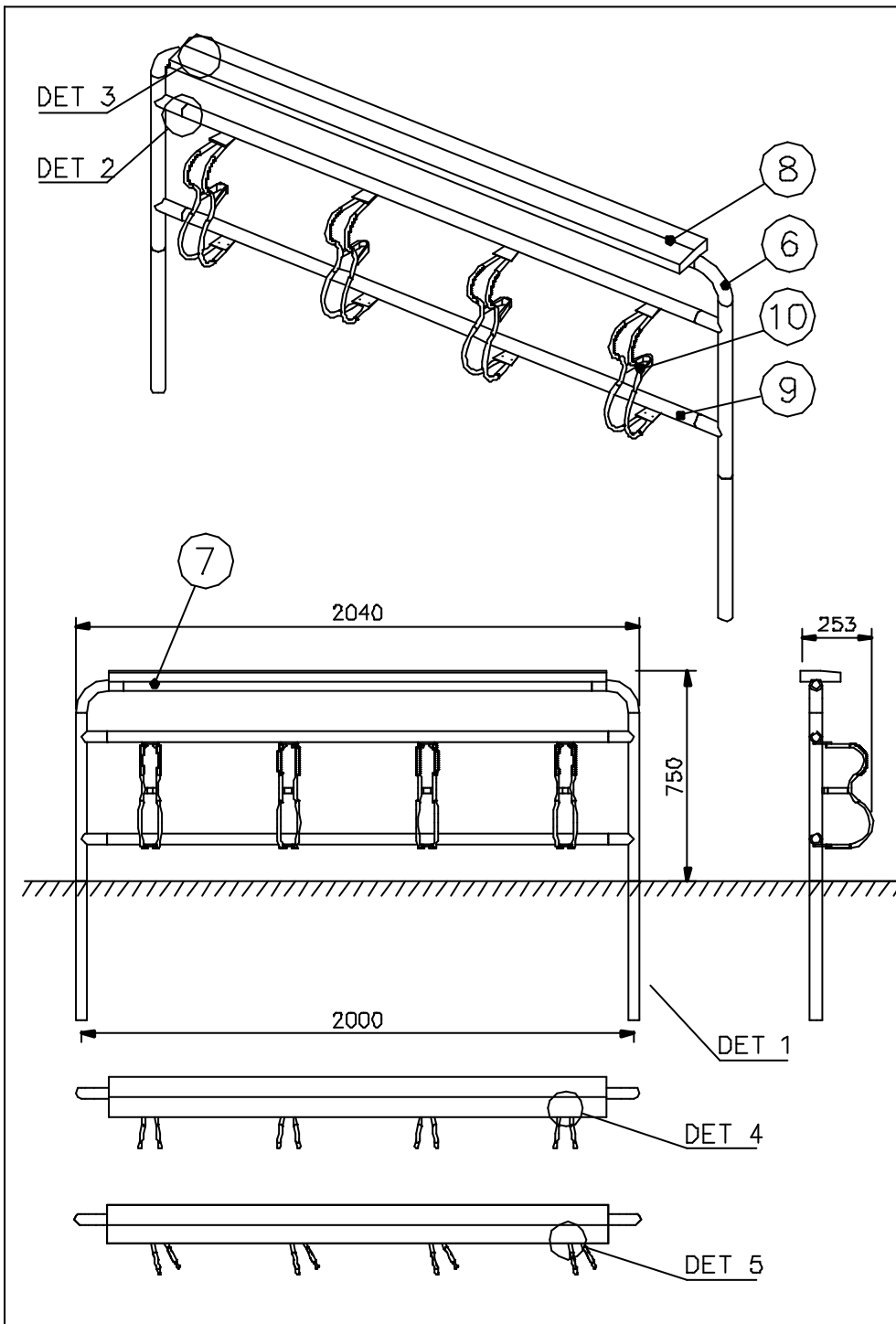







NF7612A

DATUM: 15.9.2003

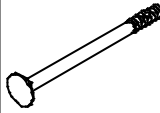
1(1)

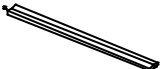
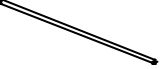
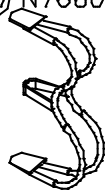

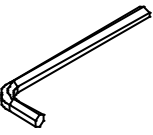
① N00103	ST	② N01801	ST
	4		2
M6		M8	
③ N01830	ST	④ N03816	ST
	8		2
8x30		Ø8.4x16x1.5	
⑤ N50880	ST	⑥ N76121	ST
	2		2
8x80			
⑦ N76123	ST	⑧ N76124	ST
	1		1
⑨ N76603	ST	⑩ N76605	ST
	2		4
⑪ N76606	ST	⑫ N00104	ST
	8		1

